

## INTERPRETING STRAIN MEASUREMENTS FROM LOAD TESTS IN BORED PILES

Jack Hayes, Loadtest Inc., Gainesville, Florida, USA  
Tony Simmonds, Geokon Inc., Lebanon, New Hampshire, USA

---

Vibrating wire strain gages have proven to be a very reliable and effective tool for the measurement of strains associated with the loading of bored piles (drilled shafts). However, when these strains are used to calculate the load, or stresses in the pile, the results can sometimes be confusing and/or difficult to interpret.

This paper describes some of these situations, using examples from actual case histories, and discusses some of the difficulties associated with residual load effects, curing and temperature induced strains, load stress distribution effects, estimated modulus and area.

### PILE LOAD TEST INSTRUMENTATION

An expanding requirement to build on difficult terrain has seen an increase in the use of piles for support of buildings and infrastructure, and a growing need for tests to determine pile load capacities.

The load distribution along a pile, among friction (side shear) and end bearing, is often measured using strain gages embedded in the pile.

#### Choice of Strain Gage.

In static load tests vibrating wire strain gages are generally used. The advantage of vibrating wire sensors over more conventional electrical resistance or semi-conductor types lies mainly in the sensor output, which is a frequency rather than a voltage or resistance. The frequency output is easier to transmit over long cables and is unaffected by voltage drops such as those which can be brought about by corrosion of terminal contacts, moisture penetration into either the sensor or the signal cable, or temperature effects on the cable, all of which would radically affect the output of electrical resistance types. Also, shortening or lengthening of the sensor cables does not affect the frequency signal.

Vibrating wire gages are, by design, very robust, allowing for quick and simple installations. Electrical resistance strain gages, on the other hand, tend to be fragile and their installation requires more care and diligent waterproofing.

Recently fiber optic strain gages have been used but they are comparatively expensive, especially the readout equipment, and care is needed when handling the delicate fiber optic cables during installation. They can, however, be made in long lengths so that total coverage of the entire length of pile is possible. As time goes by, and as prices come down, we may well see more widespread use of fiber optic sensors.

Vibrating wire gages are read electronically using portable readout boxes or with dataloggers. In recent years dataloggers, have become miniaturized, less power demanding, more reliable and more affordable,

and consequently are seeing more widespread use, even on relatively small scale projects such as pile tests. Dataloggers are able to gather data more quickly and with reduced manpower, and lighten the burden of data analysis.



**Figure 1 - Datalogger system used to monitor instrumentation during a lateral load test**

For long term monitoring, over extended periods of time, vibrating wire sensors are the sensors of choice. Properly constructed, (McRae et al. 1991) they have an excellent long-term stability, far exceeding the best of bonded foil type strain gages and equaling or exceeding that of the unbonded (Carlson) type sensors.

In one important respect only is the vibrating wire sensor deficient, it is unable to monitor rapidly changing parameters. It is better, where dynamic responses are to be measured, to use electrical resistance or semi-conductor type sensors.

#### Vibrating Wire Strain Gages

A technique for measuring strains using the vibrating wire principle was developed in 1931 by Andre Coyne, a French consulting engineer (Bordes et al. 1985). Later, in the same decade, vibrating wire strain gages were made commercially available by Maihak, (Germany), and Telemac, (France). Other manufacturers based designs on developments by the Buildings Research Establishment, (Gage Technique)

in England, and by the Norwegian Geotechnical Institute, (Geonor). Beginning in the 1970's and continuing to the present day, the variety and versatility of vibrating-wire sensors have been greatly expanded by Geokon Inc, in the USA. Figure 2 shows a typical vibrating wire concrete embedment strain gage.

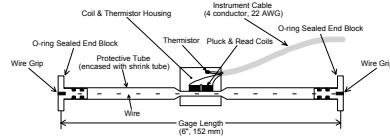

Figure 2 - Vibrating Wire Embedment Strain Gage

A tensioned steel wire is made to vibrate by means of an electronic coil. This same coil, in conjunction with a permanent magnet, is also able to measure the frequency of this vibration, which changes as the strain in the wire changes. The concrete embedment style has flanges at each end to engage the concrete. Larger gages are used in mass concrete with large aggregate, up to 150mm (Sellers, 2002).

**“Sister Bar” Strain Gage**

A variant of the vibrating wire strain gage is the Rebar Strain Meter or “Sister Bar” shown in Figures 3 and 4.

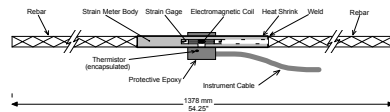

Figure 3 - Rebar Strain Meter

The Geokon 4911 “Sister Bar” consists of a miniature vibrating wire strain gage installed inside a 150mm length of high strength steel on the neutral axis. This configuration, is preferable to types where a vibrating wire strain gage is simply attached to the side of a section of rebar as it is not sensitive to bending. The strain meter body is then welded between 2 rebar extensions. The welds are tested and the gage calibrated in a testing machine (traceable to the N.I.S.T.). The method of construction results in a very robust strain gage, which will survive almost any kind of concrete placement method. The long section of reinforcement bar provides good contact with the concrete over a long distance so there is less likelihood of the active portion of the gage being influenced by local cracks, fissures or air bubbles.

Sister bars, as the name implies, are attached alongside the longitudinal rebars of the rebar cage (Dunncliff, 1988). Sometimes the sister bar is specified to be of a size equal to the rebar. A section of the rebar is to be removed and is to be replaced by a sister bar welded directly into the rebar cage so that it becomes part of it. This requires two more full strength welds to be made. Since the performance of the strain

gage is in no way enhanced by this procedure, the additional time and expense cannot be justified.

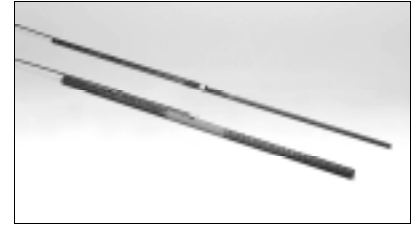

Figure 4 - Rebar Strain Meters

**Sister Bars or Embedment Strain Gages?**

Sister bars are often chosen for cast-in-place concrete piles, where concrete is tremied or dropped into a drilled shaft, because they are more rugged and better able to maintain their alignment than embedment type strain gages (as shown in Figure 2). In pre-cast concrete piles, the smaller embedment types are suitable. (High temperature versions of Sister Bars and embedment types are available for heat cured spun piles).

Sister bars may also be chosen because they allow a direct measurement of the rebar stress, whereas the embedment strain gage measures the concrete strain – a combination of shrinkage, swelling, creep and that due to applied stress.

**Gage Protection**

Sister bars (and embedment gages) are usually located at the same circumference as the rebar cage and are thus protected from being scraped off as the rebar cage is lowered into the drilled shaft. Under normal circumstances, the survivability of either type of gage is close to 100 percent.

Cables need to be protected by tying them off to the longitudinal rebars at about 2-meter spacing. If the cables are tucked into the angle between the spiral rebar and the longitudinal rebars, and kept tight, they will be safe (Sellers, 1995).

**PILE LOAD TEST – OSTERBERG METHOD**

A new way of load testing piles uses the Osterberg Cell, a hydraulic jack-like device embedded in the pile (Osterberg, 1989). In the case of a caisson or cast-in-place pile the device (or O-cell) is attached to the rebar cage. Hydraulic lines and telltales extend from the O-cell to the top of the pile to monitor the movement of the bottom of the pile as the O-cell load is applied. Either dial gages or displacement transducers measure movement of the top of the pile.

More sophisticated instrumentation schemes use strain gages to measure the load distribution in the pile in the zone above and below the O-cell. In this way, as the loads are applied, the distribution of the load transference to the ground by induced shear forces can be measured. Figure 5 shows a typical arrangement of instruments in an Osterberg Cell load test.

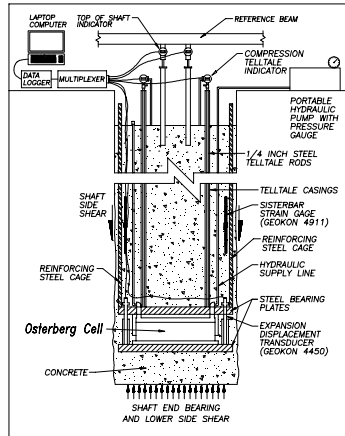

Figure 5 — Typical Instrumentation for an O-cell Test

### Strange Strain Situations

One of the distinct advantages of a static load test on a pile or drilled shaft is that it can provide the engineer with valuable information about the actual ultimate end bearing or side shear characteristics of the pile or drilled shaft. In a conventional top-down load test, the separation of the end bearing and side shear components requires embedded strain gages to determine the resisting shear loads developed along the shaft. The shear load resistance, so determined, is subtracted from the total applied top load to estimate the end bearing resistance.

A significant advantage of carrying out static load tests using the O-cell method is that separation of end bearing and side shear resistance is generally provided without the need to rely on strain gages for that purpose. Nevertheless, even with an O-cell test, the engineer is often interested in the distribution of side shear along the shaft. Thus most O-cell tests also have strain gages embedded in the shaft.

Determining loads from strain gages requires an analysis of the strain gage data that is usually more sophisticated than many engineers realize. For example Fellenius (2002) provides convincing evidence of the impact of residual loads on strain gage data when testing either driven piles or bored piles (drilled shafts). From our experiences with analyzing the data from hundreds of static load tests we can

confirm that converting strain into loads in a drill shaft is not a simple matter. We have encountered many apparently strange strain situations that sometimes seem to defy logic. Often one of the hardest things to do when interpreting strain gage data is to trust the strain gages. Virtually all of the strain measurements in our tests have been made with vibrating wire sister bar strain gages (Geokon 4911). After analyzing the data from many thousands of this type of vibrating wire strain gages we have learned to trust them. Thus when the data seem unrealistic we have become accustomed to looking for a reason and we now are aware of many reasons for strange-looking strain gage data.

### Residual Load Effects

As illustrated in Figure 6, the presence of residual toe loads in driven piles is readily evident from O-cell end bearing (loading and unloading) movement curves. Residual side shear loads are, however somewhat more difficult to detect, especially in drilled shafts. Although not done routinely, strain gages in test shafts can be monitored throughout the installation, construction and concrete curing phases. As noted by Fellenius (2002) using only "zero readings" taken at "zero time at the beginning of a load test ignores the strain history of the shaft which can lead to the locked in loads.

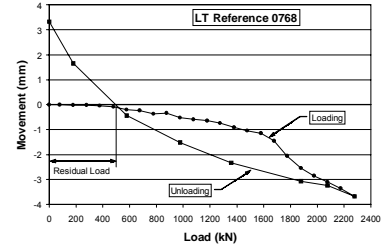

Figure 6 - Residual Toe Load in a Driven Pile

We believe that the physical expansion and contraction of the pile shaft concrete during the curing period results in significant residual side shear loads. Using the full capability of Geokon 4911 strain gages to monitor both temperature and internal strain during the curing period produces the kind of data shown in Figures 7 and 8.

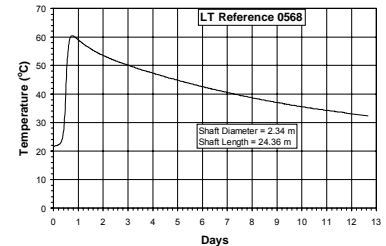

Figure 7 - Concrete Curing Temperature

Figure 7 shows the internal temperature history of the curing shaft with a diameter of 2.34 meters and a length of 24.4 meters. Figure 8 illustrates the internal strain history for two levels of gages in the same drilled shaft.

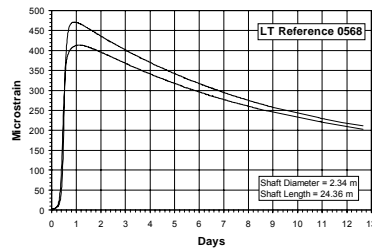

Figure 8 – Internal Strain History During Curing

From these strains we can make an estimate of the side shear loads that appear to have developed during the curing period in the zone between these two strain gage levels. We computed the side shear values from the strain data using concrete moduli estimated, with the ACI formula, from concrete cylinder strengths. We obtained test cylinder data over the curing period of one to fourteen days. (This method of estimating moduli is, of course, subject to all of the limitations and error margins subsequently discussed.) In this case the movement of the shaft during the curing period resulted in an estimated tension and then compression “locked in shear” of  $\pm 130$  kPa. (See Figure 9.)

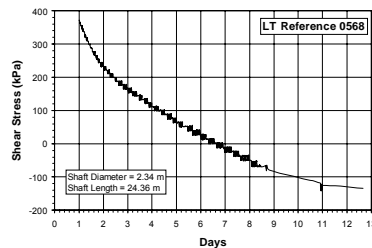

Figure 9 – Estimated Side Shear Stresses During Curing Period

#### Influence of Tension Cracks

We are aware of incidents of tension micro-fractures forming on the plane of embedded strain gages during the curing period. Such micro-fractures can distort the shaft loads computed during the early stages of loading. Until the subsequent applied compression loads close the micro-fractures, only the modulus and the area of the reinforcing steel should be used to compute the shear load distribution. This impact of micro-fractures on gage data would normally apply only to relatively low loads at the beginning of a test.

#### Concrete Modulus Influences

Typically the loads at the plane of the strain gages are computed from the measured strains and an estimated modulus using the formula:

$$P = cAE$$

Where:

$P$  = load

$c$  = measured strain from gages

$A$  = composite cross-sectional area of concrete and steel in the shaft at the plane of strain gages

$E$  = composite modulus of concrete and steel at the strain gage plane.

The concrete modulus is often estimated from the ACI formula:

$$E_c = k (f'_c)^{0.5}$$

which is based on the square root of the unconfined compressive strength,  $f'_c$ , of the concrete. Commonly we use a value for the constant,  $k$ , of 4,700 when  $f'_c$  is in MPa units. This method may provide reasonable values for the  $E_c$  used to calculate loads from strains, but not always, for the following reasons:

1. The ACI formula is based on retrogression through scattered data. Various researchers have found that the constant,  $k$ , can vary significantly for different concrete mixes. In fact the ACI formula constant of 4,700 is supposed to apply to “normal weight” concrete of  $2320 \text{ kg/m}^3$ . The ACI Building Code actually recommends that the constant,  $k$ , be determined from the expression

$$0.043 w^{1.5} \quad (\text{Oluokun et al, 1991})$$

where

$w$  = unit weight of the concrete in MPa

This implies that, for an increase in unit weight from  $2240$  to  $2500 \text{ kg/m}^3$ ,  $k$  increases by 17%. Based on other studies (Shah and Ahmad, 1985 and Freedman, 1971) researchers have concluded that concretes comply with the ACI formulations within  $\pm 20$  percent.

2. The unconfined compressive strength may not reflect the actual strength of the concrete in the shaft. It is generally acknowledged that the elastic modulus of concrete correlates well to the 0.5 power of the compressive strength of the concrete in the shaft. Studies by Khan et al (1995) suggest that the normal methods used to cure concrete test cylinders result in compressive strengths that are significantly lower than those of the mass concrete in the shaft.

3. The modulus of the concrete will generally not be constant through the range of compressive loads during a test. As noted by Fellenius (2001), “over the large stress range imposed during a static loading test, the difference between the initial and the final moduli for the pile material can be substantial.”

**Tangent Modulus Estimates**

Fortunately the shortcomings of using the ACI formula for estimating the concrete moduli can be overcome by using the procedures described by Fellenius (1989), (2001) to determine the tangent modulus of the concrete from the test data. The procedure is based on the fact that, after the side shear on a shaft is fully mobilized and no longer changes with loading, the changes in stress and strain at the plane of the strain gages reflect the composite modulus of the shaft at that loading. An example of a tangent modulus plot from Loadtest, Inc. data is shown on Figure 10.

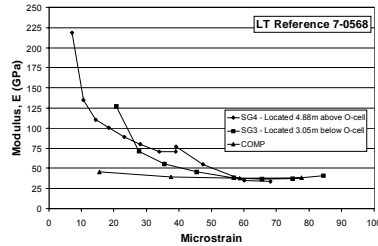

Figure 10 – Tangent Modulus Plot

We sometimes have the opportunity to compare the results of a tangent modulus analysis with a more direct measurement of the modulus in a multi-level O-cell as illustrated in Figure 11. By applying equal and opposing loads with O-cells 1 and 2 while measuring the shaft compression with embedded telltales we can carry out a full-scale modulus test. The results of such a test are shown on Figure 10 (▲ comp) providing an example of a good comparison.

One of the additional benefits of the “tangent modulus” technique for analyzing strain gage data is that it also compensates for any uncertainty that may exist about the area of the shaft on the strain gage plane. In a driven pile of fixed dimensions the value for area, A, is well known. In a drilled shaft, however, we usually know the diameter of the shaft only approximately, making it difficult to derive the correct value for E. We can, however, use the tangent modulus technique to determine the value of AE with some confidence. The technique plots the known increase in load with respect to the measured increase in strain allowing us to calculate  $AE = \Delta P / \Delta \epsilon$ . The plot shown in Figure 12 indicates AE values relative to strain.

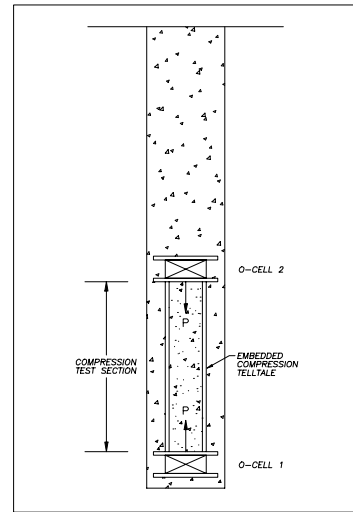

Figure 11 - Multi-level O-Cell Setup Used for Compression Test

Although the “tangent modulus” analytical tool does help to overcome some of the drawbacks of traditional analysis, it does have limitations. One has already been mentioned; the need to reach or exceed ultimate side shear values during the test. A second limitation is that the total strain at the plane of interest, based on our experience with drilled shafts, must reach at least 50 micro-strain and preferably more than 200 micro-strain. Figure 12 (SG1 and SG2) shows a typical tangent modulus plot with relatively low concrete compressive strains.

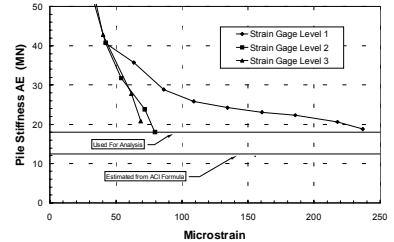

Figure 12 —Tangent Pile Stiffness Analysis for Strain Gage Levels 1, 2, and 3

### The Influence of Shape

One of the significant uncertainties relating to drilled shafts is the actual size and/or shape of the shaft. Without good caliper data, we usually do not know, with any precision, the area of the concrete on the strain gage plane. Table 1 provides a reminder that relatively small changes in shaft diameter translate to significant changes in area. It is not hard to imagine situations with a 20% error in the assumed value for the area, A. Combine that with a 20% error in the estimate of E from the ACI formula and we have a potential 40% error in the estimated value for AE. Sometimes these errors may compensate, producing an accurate result but we can never be certain about that.

**Table 1 – Impact of Uncertain Shaft Diameter**

Nominal Diam. (m)	Nominal Area (m <sup>2</sup> )	Actual Diam. (m)	Actual Area (m <sup>2</sup> )	Percent Increase
1.0	0.79	1.1	0.95	21.0
1.2	1.13	1.3	1.33	17.4
1.5	1.77	1.6	2.01	13.8
2.0	3.14	2.1	3.46	10.3
2.5	4.91	2.6	5.31	8.2
3.0	7.07	3.1	7.54	6.8
1.0	0.79	1.2	1.13	44.0
1.2	1.13	1.4	1.54	36.1
1.5	1.77	1.7	2.27	28.4
2.0	3.14	2.2	3.80	21.0
2.5	4.91	2.7	5.72	16.6
3.0	7.07	3.2	8.04	13.8

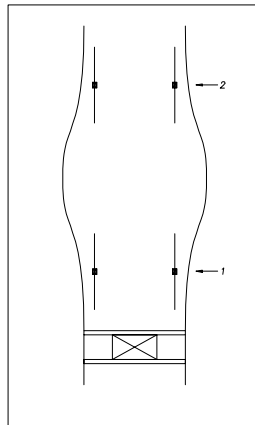

**Figure 13 - Influence of Shape on Strain Measurements**

The shape can also influence strain measurements in other, less obvious ways. Figure 13 illustrates a situation where the shaft diameter between strain gage

levels is larger than at the strain gage planes above and below. An axial load applied from below will result in abnormally high strains at level 1 and abnormally lower strains at level 2 because of the “bulge” in the shaft. The consequence will be a false indication of higher unit shear values in the zone between Levels 1 and 2. We can only conclude that a proper strain gage analysis requires good caliper data.

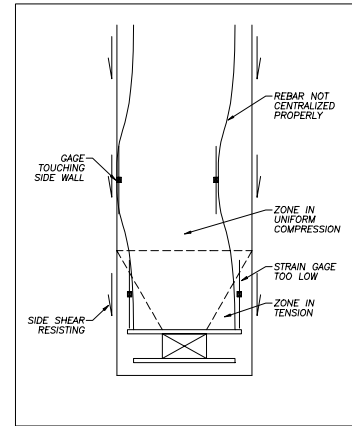

**Figure 14 - Influence of Installation Technique**

### Influence of Gage Positions

A number of apparently anomalous strain measurements can be related to the position of the strain gage relative to the applied load. For example, in an O-cell test, it is important to position strain gages more than one shaft diameter above the top of the O-cell itself. Figure 14 illustrates how a gage placed too close to the point of load application can actually indicate tensile strains in a shaft loaded in compression.

The position of the gage can also produce results that illustrate defects in shaft design and/or construction. As shown in Figure 14, a shaft cage with tight hoop spacing and inadequate cage centralizers can both drag material from the sidewalls onto the rebar hoops and also come to rest with one side of the cage in contact with the sidewalls. In such situations a sister bar strain gage attached to the hoops may not (probably will not) get embedded in concrete. Such a gage merely “goes along for the ride” during the test and thus measures apparently very low strains. Since the gage located on the opposite side, being fully embedded in concrete, produces much higher strains, engineers sometimes conclude that the shaft is being loaded “eccentrically.” In reality, however, the strain gages have simply let us know that we have a defect in the design and/or construction of the shaft.

## **CONCLUSIONS**

- Calibrated vibrating wire sister bar strain gages with thermistors can provide very reliable and useful data for analyzing drilled shaft performance, but unfortunately not unambiguously.
- Calculating loads from strain gage data requires an awareness that pre-test strain history can result in significant locked-in shear and end bearing loads.
- Conventional methods used to estimate both area and modulus for concrete can lead to errors of 40% in loads computed from strain data.
- The "tangent modulus" analytical technique described by Fellenius sometimes provides a superior method for assessing loads from strain data.
- The shape of a drilled shaft can influence both the strain and the calculated shear loads. A good strain gage analysis needs good caliper data.
- Seemingly strange data should not be discarded as they may point to a defect in design or construction. Each strain gage gives data that means something.

## **REFERENCES**

- BORDES, J.L., DEBREUILLE, P.J., 1985. Some facts about long term stability of vibrating wire instruments, Reliability of Geotechnical Instrumentation, T.R.B. Record No. 1004, pgs. 20-27
- DUNNICLIFF, J., 1988. Geotechnical instrumentation for monitoring field performance. John Wiley & Sons.
- FELLENIOUS, B.H., 2002. Determining the true distributions of load in instrumented piles, ASCE International Deep Foundation Congress, Orlando, Florida.
- FELLENIOUS, B.H., 2001. We have determined the capacity, then what? Fulcrum, Newsletter of the Deep Foundations Institute.
- FELLENIOUS, B.H., 2001. From strain measurements to load in an instrumented pile, Geotechnical News Magazine, Vol. 19, No.1 pgs. 35-38.
- FELLENIOUS, B.H., BRUSEY, W.G., and PEPE, F., 2000. Soil set-up, variable concrete modulus, and residual load for tapered instrumented piles in sand, American Society of Civil Engineers, ASCE, Specialty Conference on Performance Confirmation of Constructed Geotechnical Facilities, ASCE Geotechnical Special Publication, GSP 94, p. 16.
- FREEDMAN, S., 1971. High strength concrete, Modern Concrete, Vol. 34, No. 9, pp. 15-22.
- KHAN, ARSHAD A., COOK, WILLIAM D., and MITCHELL, DENNIS, 1995. Early age compressive stress-strain properties of low, medium, and high-strength concretes, ACI Materials Journal, vol. 92, No. 6, p. 617.
- McRAE, J.B., SIMMONDS, T., 1991. Long-term stability of vibrating wire instruments; One manufacturer's perspective, Proceedings of the 3<sup>rd</sup> International Symposium on Field Measurements in Geomechanics, Oslo, Norway, Sorum (Ed), pgs. 283-293.
- OLUOKUN, FRANCIS A., BURDETTE, EDWIN G., and DEATHRAGE, HAROLD J., 1991. Elastic modulus, Poisson's ratio, and compressive strength relationships at early ages, ACI Materials Journal, Vol. 88, P. 3.
- SELLERS, J.B., 1995. Pile load test instrumentation, Instrumentation in Geotechnical Engineering, Proceedings of Geotechnical Division of the Hong Kong Institute of Civil Engineers, pgs. 23-33.
- SELLERS, J.B., 2002. The measurement of stress in concrete. Japan. (to be published).
- SHAH, S. P., and AHMAD, S. H., 1985. Structural properties of high strength concrete and its implications for precast prestressed concrete, Journal of the Prestressed Concrete Institute, Vol. 30, No. 6, pp. 92-119.